

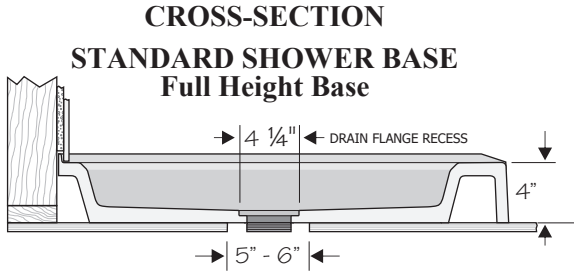

SHOWER BASE INSTALLATION

The tips and hints on this page are compiled from years of experience and the recommendations of professionals, to help you do a perfect job of installing your Shower Base, Wall Panels, and Accessories

Curb Style and Sizes



Complies with all the requirements of ANSI Z124.1.2-2005 and ANSI Z124.2-1995.

LOW-PROFILE BASE

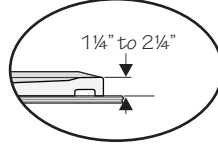

LOW-PROFILE BASE WITH ADD-ON RAMP

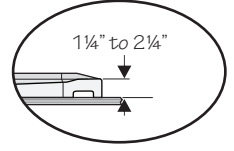

MID HEIGHT BASE

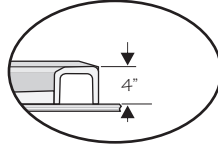

FULL HEIGHT BASE

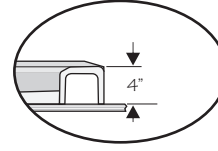

RAMPED CURB BASE

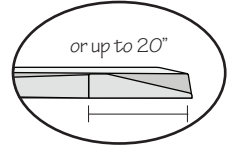

1 Preparing the Floor

Verify that the floor is firm and structurally sound. If the floor has any flexibility, add support where needed.

Make sure the floor is level, flat and clean. If the floor is not level, use Thinset or another leveling mix as needed (let harden before setting the base). All nails and screws in the floor must be countersunk so nothing sticks up above the surface. Cut about 5" - 6" hole in the sub floor to ensure drain clearance when setting the base.

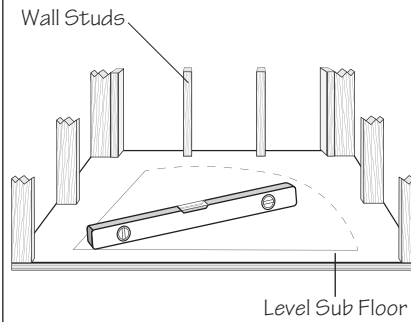

The Onyx base can be installed onto wood sub floors, concrete, underlayment board such as HardiBacker, tile, vinyl or other similar flooring materials.

Avoid setting the base into wet concrete or Thinset because the base will need to expand and contract slightly with temperature change.

CONCRETE floors need to fully support the base with only a 5-6" hole for the drain.

WOOD floors must be properly supported with studs so plywood does not sag.

Do not use spray foam under the base.

2 Installation Overview

The picture to the right is very helpful. Notice the expansion gap between the base and the wall stud as well as the small clearance gap between the flange and the wall board. These are important and should be maintained as much as possible.

The Onyx wall panel or tile is to be installed to the inside of the water flange and needs to be sealed with 100% silicone only.

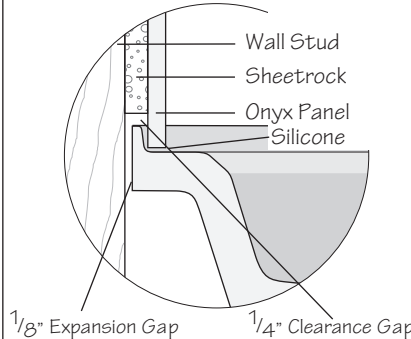

Walls should be plumb and framing should be completed before the shower base is installed.

Also, install wood backing needed for all shower seats, grab bars, and shower doors before installing the base.

If the shower base fit is too tight between the studs, the wall studs can be notched or sanded a little to give the proper gap between the base and the wall studs.

3 Drain Options

No-Glue Drain:

The drain is attached to the base before the base is installed or if you do not have access to the drain pipe from below. Be sure to put a bead of silicone between the drain flange and the base.

Glue-On Drain:

This drain style can be installed before or after the base is set in place. A bead of silicone is also used on this drain between the drain flange and the base. Then install the pipe.

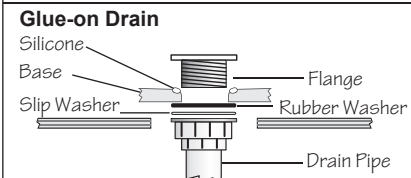
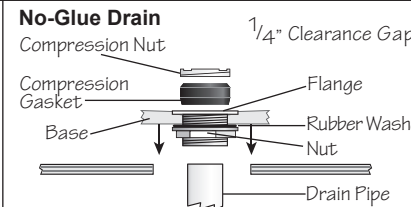

When installing your drain, use the Onyx silicone sealant that comes with each shower base. Never use gaskets on the top side of the Shower Base where the drain flange seals. Never use plumber's putty.

Most 2" shower drains work well with our shower. It is important to center the drain flange in the base drain area so that the strainer will be centered when installed.

For a guaranteed fit, use a shower drain from the Onyx Collection.

4 Setting the Base

Clean the floor as needed and then lower the base into place. It is important that there is a small expansion gap (about 1/8") between the base and the wall studs.

Note: Do not set the shower base onto spray foam

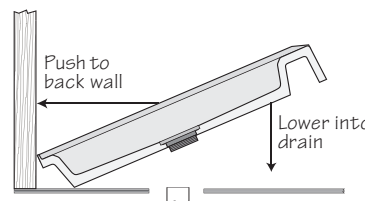

Silicone may be used to secure the base to the floor. A small bead of silicone under the front edge of the threshold will help prevent water from getting under the base.

Silicone is also helpful for filling in any small uneven areas of the floor.

5 Leveling the Base

Very Important



At this step, make sure the base is level



Be sure to set the level on the upper deck, not down in the pan.

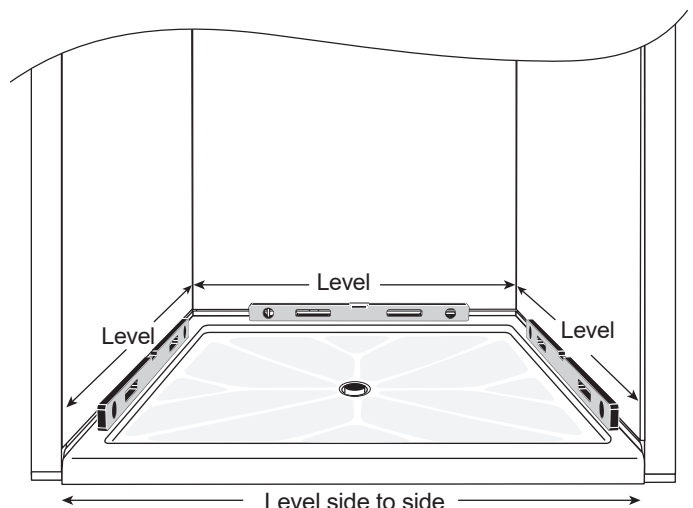

SHOWER BASE INSTALLATION

6 Framing for "Walk-In" Custom Bases

For Framing "Walk-In" Showers, it may be necessary to install the base before framing the return walls. When framing walls, allow 1/8" spacing for expansion.

Also remember to double studs as needed for shower door mounting.

Keep in mind stud location and wood backing for accessories such as caddies, seats and grab bars.

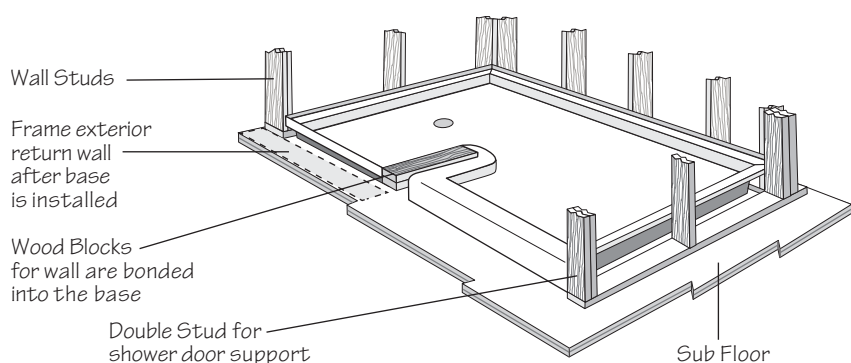

7 Finishing and Flooring

Finish flooring materials can run "up to" or under the shower base.

For tile flooring, suggested installation is to run the tile up to the Onyx base and put grout (flexible type grout is preferred) or Onyx color-matched sealant where the tile meets the base.

For vinyl flooring, suggested installation is to install the vinyl before the base and put a bead of silicone where the base meets the vinyl.

Tile Flooring - Suggestions

Flexible Grout or Silicone

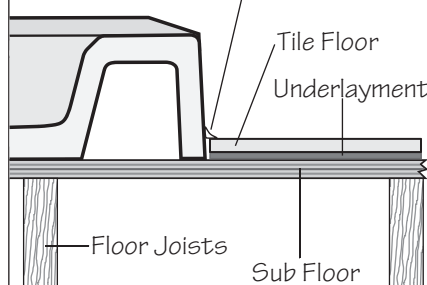

Vinyl Flooring - Suggestions

Flexible Grout or Silicone

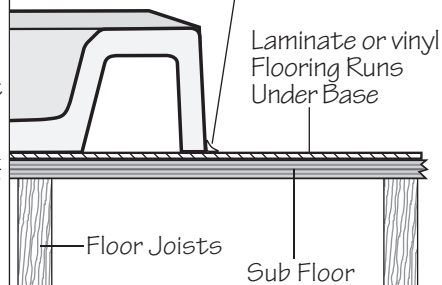

Other Helpful Suggestions & Solutions

What to do if a base is not flat:

If a base is not flat, it can be corrected by simply laying it on a hard, flat surface overnight with weight on any high points (10-50 lbs. is enough).

To flatten the base faster, gradually apply more weight on the high points and heat (normally heat is necessary, an electric blanket, hair dryer or setting outside in a warm temperature will work well). Try to get the temperature to 90 degrees. The base should flatten within 30 minutes to an hour.

Dewarp Shower Base Tutorial: <https://vimeo.com/showcase/onyxvideos>

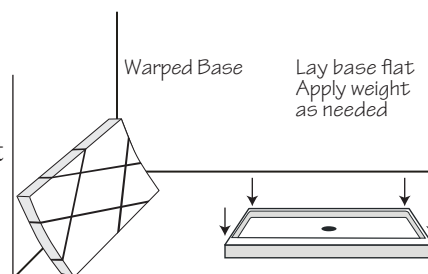

Preventing damage to base:

Most damage occurs when a tool or other object, such as a wall tile, is dropped on the base. This damage can be repaired, but it is best to prevent this by covering the shower base with a drop cloth, cardboard, or a piece of OSB board or plywood (when a lot of tile work is being done this may be a good idea).

Also, watch for screws, dirt, or other debris that can fall onto the base and will possibly cause scratches if stepped on.

Avoid dropping tools or tiles on base

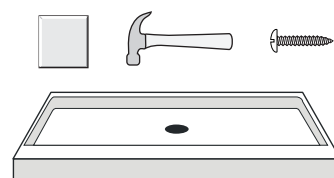

Cleaning and Care

Your Onyx products can be cleaned using almost any liquid household cleaner (except those that have abrasive particles in them which can scratch the Onyx surface). We offer a cleaner and surface protector (Eliminate® and Repel®), but most quality cleaning products you can buy locally will work well. After cleaning, use Repel® or Gel Gloss® to make future cleaning easier. For heavy cleaning, a soft brush can be used.

Also, ventilation is important to help reduce water spots and mineral deposits, so keep doors open when possible.



Preventing Trapped / Longstanding Water

If left for long periods of time, wet soap bars, bottles, or shower mats etc. which can trap water under them, can cause water penetration. If this happens, simply move the item to allow that area to "dry out". Move and clean under these type of items routinely.

Videos

Installation videos for shower bases and most of the Onyx products are available on our website. <https://onyxcollection.com/instructions-install-videos/>

